



PREMIUM QUALITY
BATHROOMWARE

Since 1853

WHY CHOOSE HENRY BROOKS ?

Of all the rooms in your house, the bathroom is the one that most needs to be rugged and hardwearing. Even more than the kitchen, the bathroom has it tough.

It's subjected to extremes of humidity and temperature all year round and it has to cope with the entire family, every single day, often when they're rushing to get to work or to school, so doors get banged, drawers get slammed, taps get bumped or closed too hard and hairdryers get dropped – we all know how it goes. In other words, today's beautiful new bathroom can look pretty sad after just a few short years.

So the bathroom is definitely an area where quality counts, and no one knows this better than Henry Brooks & Co. We've been in the business for a long, long time, since 1853 in fact. After all those years, we're still going strong and we're still very much a 100% New Zealand owned and operated family business.

No company gets to stay in business for that long without having something unique behind them, especially in today's ultra-competitive globalised world.

For Henry Brooks & Co, it comes down to three things:

1. The very best quality products
2. Superb customer service
3. Specialisation

CONTACT DETAILS

Henry Brooks Co.

Head Office: 5 Smales Road, East Tamaki, Auckland

Phone: 09 913 3110 Fax: 09 913 3113

Email: sales@henrybrooks.co.nz

Web: www.henrybrooks.co.nz





THE VERY BEST QUALITY PRODUCTS

Quality always matters but it never matters more than when you're dealing with a difficult environment like a bathroom. So we source and manufacture products that are designed to last. We won't compromise on quality. We never have and we never will. However, we're still very aware of price versus performance, so we're always aiming to offer the best value for money in New Zealand.

Our experienced team carefully considers every aspect of all of our products before we offer it to the market. If there's something we're not happy with, then it gets sorted out long before it gets to our showrooms, let alone to our customers. This means that our products last and that bathrooms designed around our products look better for longer. They'll look great too because we're very aware of modern tastes and design trends. Frankly, if we wouldn't put it in our own homes, then we won't sell it. End of story.



SUPERB CUSTOMER SERVICE

Our customers are the lifeblood of our company and their peace of mind is vitally important to us. Without them, we simply don't have a business, so we look after them. We work closely with our showroom staff and retail partners to ensure that our customers get exactly what they want and need, and if there's a problem, any problem, we'll sort it out. Every time.



SPECIALISATION

All we do is bathrooms – we're a specialist supplier of bathroom fittings, materials and products and nothing else, so we're not distracted with any other manufacturing or retail concerns. After being in business for so long, we know our stuff and we know it well, which means you can be assured that you're dealing with the experts.



MANUFACTURING

Product design and specifications are done right here in New Zealand for New Zealand conditions and New Zealand tastes.

Products are manufactured in world class manufacturing facilities, using only the finest of materials and best work place practices available.



DISTRIBUTION

The Henry Brooks range of products are either manufactured or imported to our Auckland or Wellington Factory/Distribution centres. From our extensive stock holdings, we aim to satisfy customer orders within 48/72 hours to all corners of the country.

Henry Brooks & Co aim to keep 3 month's stock on hand at any one time and targets 90% customer order dispatch within 24 hours of order receipt.



SERVICING AND PARTS

Henry Brooks & Co prides itself on the level of spare parts we carry to support the products we sell.

We have authorised service/installation technicians throughout New Zealand who look after any servicing issues with our products.



vanities

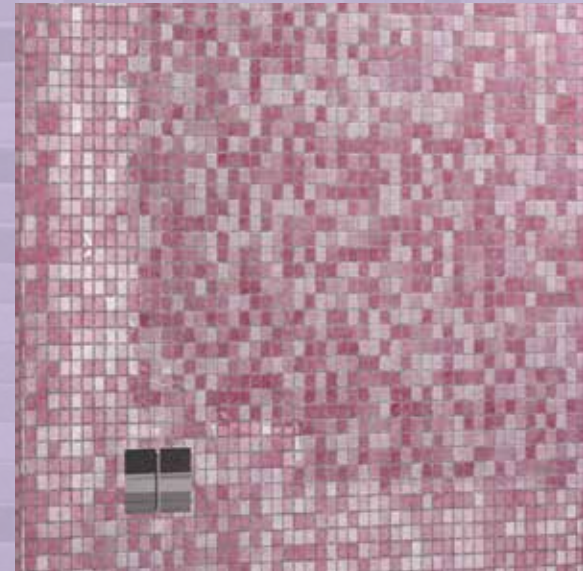

STYLISH DRAWER HANDLES



QUALITY FINISH



MODERN DESIGN



Black Oak



Brown Oak



Light Oak

Strata Woodgrain
Interchangeable
Drawer Panels

AVAILABLE SIZES

	Size	Drawers/Basins
Strata Quad 1200	1200W x 465D x 520H	4 Drawers Single Vitreous China Basin 4 Drawers Single Long Bowl Polymarble Basin
Strata Quad 1500	1500W x 465D x 550H	4 Drawers Single Large Polymarble Basin



Scan this QR code for more information on the Strata Quad

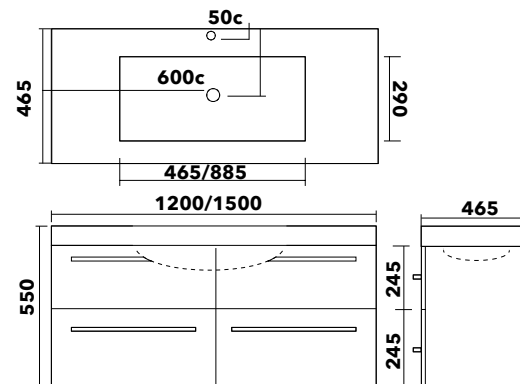

strata quad

The Strata Quad four drawer vanities are ideal for the larger bathroom. With their large single basin, they offer plenty of space on those busy mornings and with four large drawers, there's enough storage for the whole family.

FEATURES

- Available with a small square China bowl or a large rectangular Polymarble bowl
- Four big drawers offer a massive amount of storage
- Fitted with rugged, over specified hardware
- Woodgrain interchangeable drawer front panels
- Soft-close mechanisms on drawers

STYLISH DRAWER HANDLES



SOLID CONSTRUCTION



VITREOUS CHINA TOP



strata duo

The Strata range features a cutting edge ultra clean look and with the Woodgrain interchangeable drawer front panels, they can be customised to fit in with your bathroom's colour scheme. The wall hanging design allows for more floor area to be visible in your bathroom, which helps to create the illusion of space.

Like all Henry Brooks products, the Strata vanities are manufactured to our exacting specifications, constructed with highly resinated water-resistant MDF, and are finished with a hardwearing lacquered white paint, so they're ready for years of use by your family.

Strata Woodgrain Interchangeable Drawer Panels



Black Oak



Brown Oak



Light Oak

AVAILABLE SIZES

	Size	Drawers
Strata Duo 600	600W x 465D x 520H	Two
Strata Duo 750	750W x 465D x 520H	Two
Strata Duo 900	900W x 465D x 520H	Two



Scan this QR code for more information on the Strata Duo

FEATURES

- The double drawers offer a huge amount of storage space
- Ultra modern bar handles
- Woodgrain interchangeable drawer front panels
- Soft-close mechanisms on drawers

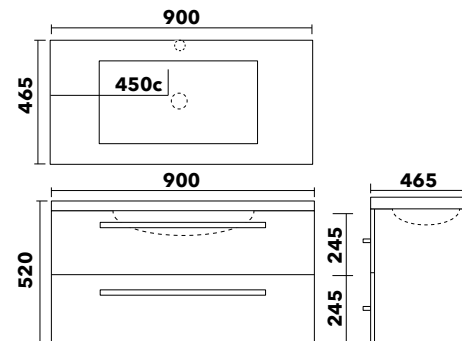



2 POT WHITE LACQUER FINISH



VITREOUS CHINA TOP



ADJUSTABLE SHELVING



albion floor standing

The Albion Floor Model range is designed to fit in with any modern bathroom décor, and our wide range of types and sizes means that we have a vanity that will fit almost any area.

Like all Henry Brooks products, these vanities are manufactured to our exact specifications, constructed with highly resinated water-resistant MDF, and are finished with a hardwearing lacquered white paint, so you know that they'll look like new for ages.

FEATURES

- Available with square basins to suit your style
- Plenty of easily accessible storage with adjustable shelves
- Hardwearing seamless lacquered white paint finish
- Fitted with rugged, quick release hinges
- Soft-close mechanisms on drawers

AVAILABLE SIZES

	Size	Doors	Drawers
Albion 500FS	500W x 250D x 850H	2	None
Albion 600FS	600W x 460D x 850H	2	None
Albion 750FS	750W x 460D x 850H	1	2
Albion 900FS	900W x 460D x 850H	1	2
Albion 1200FS	1200W x 460D x 850H	1	4



Scan this QR code for more information on the Albion

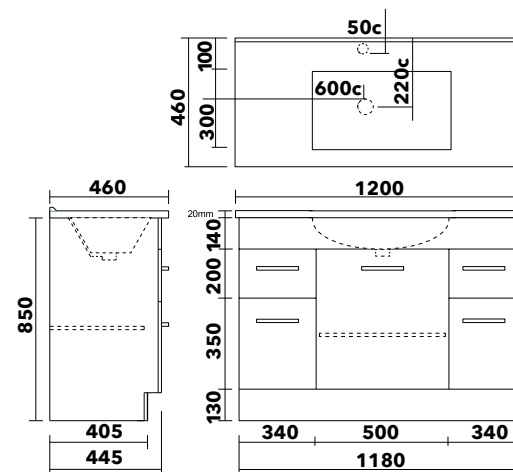



2 POT WHITE LACQUER FINISH



VITREOUS CHINA TOP



ADJUSTABLE SHELVING



albion wall hung

The Albion Wall Hung Model range is designed to fit in with any modern bathroom décor, and our wide range of types and sizes means that we have a vanity that will fit almost any area.

Like all Henry Brooks products, these vanities are manufactured to our exact specifications, constructed with highly resinated water-resistant MDF, and are finished with a hardwearing lacquered white paint, so you know that they'll look like new for ages.

FEATURES

- Available with square basins to suit your style
- Plenty of easily accessible storage with adjustable shelves
- Hardwearing seamless lacquered white paint finish
- Fitted with rugged, quick release hinges
- Soft-close mechanisms on drawers

AVAILABLE SIZES

	Size	Doors	Drawers
Albion 500WH	500W x 250D x 500H	2	None
Albion 750WH	750W x 460D x 500H	1	2
Albion 900WH	900W x 460D x 500H	1	2
Albion 1200WH	1200W x 460D x 500H	1	4

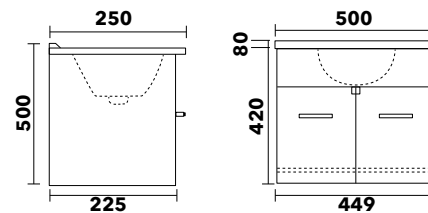

Scan this QR code for more information on the Albion



HANDLE FEATURE DETAIL



HIGH STORAGE



flash

The Flash vanity range offers a simple modern design, that delivers fantastic value for money with lots of storage space. The Flash vanity is no deeper than 400mm which makes it very easy to clean. Our designers have incorporated the handle into the front of the vanity which saves space and stops the handle protruding past the front of the cabinet, making the Flash perfect for smaller bathrooms.

The 2 available sizes of the Flash vanity ensure that we have a vanity that will make the most of storage in any small bathroom. The wall hung option allows for more floor area to be visible, helping to create a vision of space inside your ensuite or smaller bathroom.

FEATURES

- Polymarble top with modern oval basin and overflow
- Sturdy cabinet with protective white Hi-Gloss lacquer paint finish ensures no seams for a moisture-proof vanity
- 16mm thick backboard for a secure fixture to the wall
- Metal sided drawer with soft close runners
- Handle incorporated into the drawer front with the option to change the feature trim colour. Flash trim colours:



Silver Metallic Midnight Black Peacock Red Grass Green Intense Blue

AVAILABLE SIZES

	Size	Drawers
Flash 600	600W x 400D x 500H	One
Flash 800	800W x 400D x 500H	One



Scan this QR code for more information on the Flash

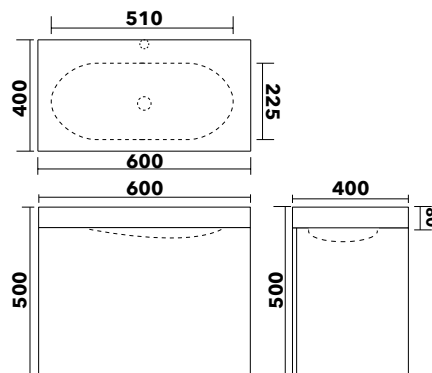

storage tall towers and mirrored wall cabinets

flash

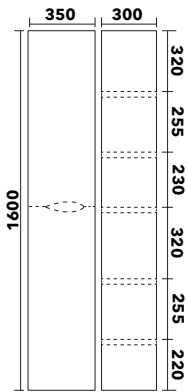

The Flash Tall Tower is a single tower unit, but with twin doors which are reversible. The Flash Tall Tower obviously compliments the two Flash vanities available on the previous page.

The feature of the recessed handle pull, allows for customization by incorporating a "flash" of colour to compliment your bathroom decor or accessories. Standard trim colours are available from us or alternatively you can personalise with your own colour choice.

strata

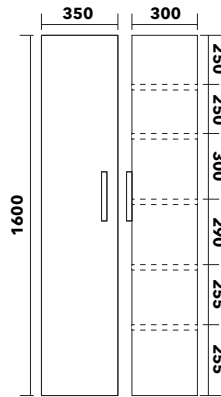

The Strata Tall Tower is a very popular addition to any bathroom, and provides an enormous amount of extra storage, while also looking stylish at the same time. The cabinet is constructed from highly resinated MDF, which is water resistant, and then painted with 4 coats of polyurethane enamel paint, to give it a high lustre finish.

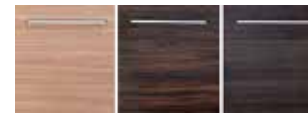

Light Oak Brown Oak Black Oak
Strata Woodgrain Interchangeable Door Panels

albion

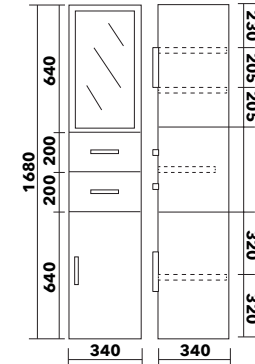

The Albion Tall Tower is a hugely popular addition to any bathroom, and provides an enormous amount of extra storage without taking up much floor space. The stylish design means that it will effortlessly complement the décor in your bathroom. Available with and without legs.

mirrored wall cabinets



These elegant and functional mirrored wall cabinets offer extra space in your bathroom and can be recessed into the wall cavity if desired. The 600 and 750 cabinets doors open outwards to give easy access to all stored items. Glass shelves and soft close cupboard doors make this a classy edition to any bathroom design.

strata slimline toilet storage



This stylish but compact toilet vanity comes in a white lacquer paint finish, or it can be optioned with any of the Strata interchangeable woodgrain door front options. The basin is reversible as is the door front.

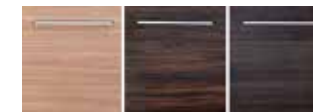

Light Oak Brown Oak Black Oak

Strata Woodgrain Interchangeable Door Panels

AVAILABLE SIZES

	Doors	Features
600	Two	The 600 cabinet doors open outwards to give easy access to all stored items
750	Two	The 750 cabinet doors open outwards to give easy access to all stored items
900	Three	The 900 cabinet outer doors open inwards so that ladies' hair and make up can be inspected from different angles
1050	Three	The 1050 cabinet outer doors open inwards so that ladies' hair and make up can be inspected from different angles

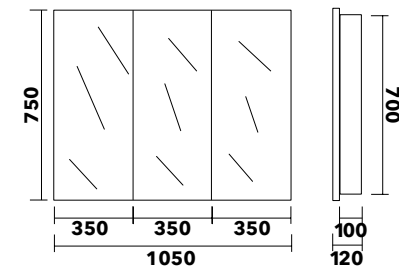

shower

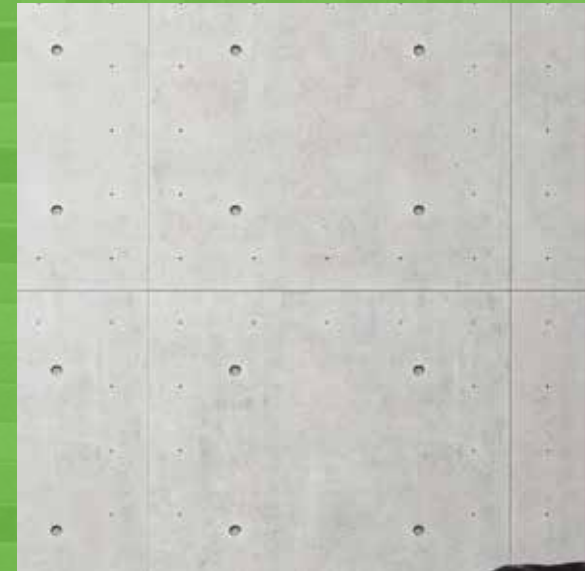

PIVOTING DOOR



STYLISH DOOR HANDLE



ACRYLIC TRAY AND 40MM UPSTAND



AVAILABLE SIZES

Size	Door	Lining
900 x 760	Chrome or White	Flat or Moulded
900 x 900	Chrome or White	Flat or Moulded
1000 x 1000	Chrome or White	Flat or Moulded
1200 x 750	Chrome or White	Flat or Moulded
1200 x 900	Chrome or White	Flat or Moulded

Shower Enclosures available in both 2 and 3 sided options

FEATURES

- Pivoting 6mm toughened safety glass door, which is manufactured and tested to comply with strict New Zealand safety standards
- Door frame constructed from rugged aluminium
- Reversible for left-hand or right-hand installation
- Chrome hinges and fixing points
- Easy to clean finish



Scan this QR code for more information on the Shower Enclosures shower range





shower enclosures

Our Shower Enclosures shower range is available in a wide range of sizes to suit any shape or size of bathroom. They can be placed in the perfect corner position to suit the layout of your bathroom and to maximise space. Like all Henry Brooks products, these showers

are manufactured to our exacting specifications, and constructed and finished with rugged hardwearing materials, so you know that they'll look like new for ages. They're practical, watertight, easy to install and have a full five-year warranty.

UNIQUE DESIGN



QUALITY CONSTRUCTION



DURABLE AND HARDWEARING FINISH



collesium

The stylish Collesium Curved Front Showers are perfect for the modern bathroom. Their curved front lends an air of elegance to the room while maximising the available space.

Like all Henry Brooks products, these showers are manufactured to our exacting specifications, and constructed and finished with rugged hardwearing materials, so you know that they'll look like new for ages. They're practical, watertight, easy to install and have a full five-year warranty.

AVAILABLE SIZES

Size	Door	Lining
900 x 900	Chrome or White	Flat or Moulded
1000 x 1000	Chrome or White	Flat or Moulded



Scan this QR code for more information on the Collesium

FEATURES

- Magnetic door seal keeps water inside your shower where it belongs
- Door frame constructed from rugged aluminium
- Durable and hardwearing finish in white powdercoat or tough chrome finish
- Made of hygienic one-piece sanitary grade acrylic with no corner joins or seams
- Totally watertight seal and tested to drain 40 litres of water per minute





CAST METAL PIVOT BLOCK



SUPPORTING BRACKET



bath swing panel

The Henry Brooks Bath Swing Panel is a great option to help keep water inside the showering area. Available in both white and chrome, this practical bath screen has a fixed panel of 400mm, which not only extends the showering area of your bath to a full 1200mm, but it also means that if a vanity is located next to the bath (as in many New Zealand homes), the door panel starts its opening arc past the end of the vanity allowing maximum entry space for versatility. The door panel itself opens both in and out and has a practical handle, which also doubles as a towel rail.

Like all Henry Brooks' products, these swing panels are manufactured to our exacting specifications, and constructed and finished with rugged, hardwearing materials, so you know that they'll look like new for ages. They're practical, watertight, easy to install and have a five-year warranty.

FEATURES

- Fixed panel of 400mm and a swing panel of 800mm
- Stainless steel door handle, which doubles as a towel rail
- Supporting bracket for strength
- 6mm glass and overall height of 1400mm
- Available in both white and chrome



Scan this QR code for more information on the Bath Swing Panel



HINGE AND BRACKET



SWING PANEL



dreamline bliss bath swing panel

For those wanting a bit more luxury, Dreamline showers are constructed in 8mm safety glass and feature solid chrome plated door hinges. A fixed panel of 450mm and an opening panel of another 750mm give maximum water coverage in a shower over bath situation.

Like all Henry Brooks' products, these swing panels are manufactured to our exacting specifications, and constructed and finished with rugged hardwearing materials, so you know that they'll look like new for ages. They're practical, watertight, easy to install and have a five-year warranty.

FEATURES

- Fixed panel of 450mm and a swing panel of 750mm
- 8mm glass
- Supporting bracket
- Overall height of 1500mm
- Frameless



Scan this QR code for more information on the Dreamline Bliss Bath Swing Panel



SPACE SAVING



STYLISH DOOR HANDLE



ACRYLIC TRAY AND UPSTAND



dreamline urban

Dreamline shower doors are frameless, functional and stylish. They are well engineered with simple clean lines and a solid wheel mechanism providing a smooth gliding motion. Dreamline showers are a practical solution for when space is limited, and are suitable in alcove or two sided tiled and acrylic shower enclosures.

Like all Henry Brooks products, these showers are manufactured to our exacting specifications, and constructed and finished with rugged, hardwearing materials, so you know that they'll look like new for ages. They're practical, watertight, easy to install and have a full five-year warranty.

AVAILABLE SIZES

Size	Waste	Configuration
1200 x 900	Left hand or Right hand	2 Sided or 3 Sided Alcove
1400 x 900	Left hand or Right hand	2 Sided or 3 Sided Alcove
1600 x 900	Left hand or Right hand	2 Sided or 3 Sided Alcove



Scan this QR code for more information on the Dreamline Urban

FEATURES

- 8mm toughened safety glass door, which is manufactured and tested to comply with strict New Zealand safety standards
- Frameless, functional and stylish
- Easy to clean finish
- Easily adjustable for the perfect installation
- Durable and hardwearing polished aluminium or 316 stainless steel extrusions and components
- Tiled wall option or acrylic wall linings available

Overall height is 2000mm

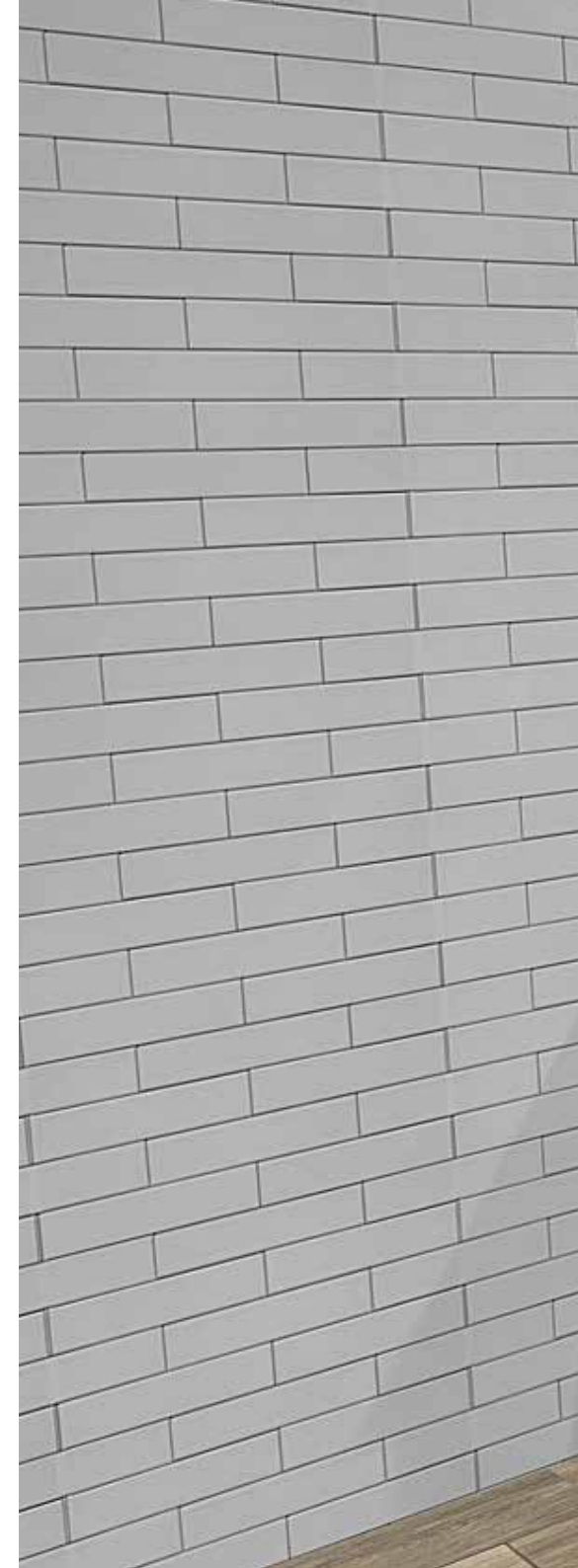



UNIQUE TRAY DESIGN



MAGNETIC SEALS AND STAINLESS STEEL HANDLE



BARREL HINGE



dreamline eclipse

Dreamline shower doors are frameless, functional and stylish. They're well engineered with simple clean lines and a unique design that makes them a practical solution for when space is limited.

This is one of the most stylish and desirable showers we stock. It's based on a roomy 1200 x 900mm acrylic shower base with a glass return panel. The 6mm glass is curved to provide a seamless and elegant showering experience offering unparalleled luxury and a sense of spaciousness. The stainless steel handle and rugged, fully opening, pivot shower door are proof that in addition to being great looking, this shower is a solid, well designed and functional addition to your bathroom.

Like all Henry Brooks products, these showers are manufactured to our exacting specifications, and constructed and finished with rugged, hardwearing materials, so you know that they'll look like new for ages. They're practical, watertight, easy to install and have a full five-year warranty.

These enclosures feature a frameless pivot glass door to suit two sided solutions only 1200 x 900mm

Overall height is 1900mm.



Scan this QR code for more information on the Dreamline Eclipse

FEATURES

- 6mm toughened safety glass door, and return panel featuring a curved corner
- Spacious and luxurious shaped shower
- Solid stainless door handle
- Unique outer lip
- 40mm tray upstand
- Available in left or right hand configurations
- Unique waterproofing features on shower tray



STAINLESS STEEL HINGES



STYLISH DOOR HANDLE



STAINLESS STEEL COMPONENTS



dreamline cube

Dreamline shower doors are frameless 8mm glass, which is functional and stylish. They are well engineered with simple clean lines and solid, stainless steel hinges. Dreamline showers are a practical solution for when space is limited. Available as a two sided option with either acrylic or tiled walls.

Based on a semi frameless design, and absolutely brimming with features, the Dreamline Cube features 8mm safety glass panels, stainless steel fittings and magnetic seals to keep the unit waterproof. The 40mm upstand ensures water tightness to eliminate leaks. The tray's outer lip stops water egress while maintaining the stylish design – there are no unsightly silicone filling gaps, and the tray is low profile at only 50mm high.

Like all Henry Brooks products, these showers are manufactured to our exacting specifications, and constructed and finished with rugged, hardwearing materials, so you know that they'll look like new for ages. They're practical, watertight, easy to install and have a full five-year warranty.

These enclosures feature a frameless pivot glass door and stainless steel hinges to suit two sided solutions 900mm to 1000mm.

Overall height is 1900mm.



Scan this QR code for more information on the Dreamline Cube

FEATURES

- 8mm toughened safety glass door, which is manufactured and tested to comply with strict New Zealand safety standards
- 40mm tray upstand for water tightness - tray lip to retain water, plus unique outer lip
- Stainless steel hinges and handle
- Elegant frameless look



freestanding baths

Elegant, functional and stylish – freestanding baths are the hottest modern sophisticated design statement. Henry Brooks has a range of freestanding baths in several styles and finishes. These baths are available in a number of sizes that will fit everyone's bathroom requirements. The smaller size baths are very popular for families with children, yet they still provide a romantic haven in an otherwise hectic household.

Like all Henry Brooks' products, these freestanding baths are manufactured to our exacting specifications, and constructed and finished with sanitary grade high gloss acrylic, so you know that they'll look like new for ages. They're easy to clean, simple to install and have a full five-year warranty.

FEATURES

- Invisible seams
- Sanitary grade high gloss acrylic surface
- Easy to clean



Scan this QR code for more information on our Freestanding Baths

AVAILABLE SIZES

Holly	1750L x 780W x 750H
Amy*	1350L x 680W x 560H 1500L x 700W x 570H
Pamela*	1200L x 680W x 560H 1400L x 680W x 560H 1500L x 680W x 560H

*Available in black



spa baths

Luxury, sophistication, style and specifically designed for your bathing pleasure. Constructed from sanitary grade acrylic and designed to be a focal point of any bathroom. Our spa baths will give you pleasure for many years and, like all Henry Brooks' products, these spa baths are manufactured to our exacting specifications and are constructed from only the finest materials and components. They are hard wearing and look fantastic for many years. All Henry Brooks' spa baths carry a full 2 year peace of mind warranty.

FEATURES

- Sanitary grade acrylic
- Ergonomic and stylish design
- Massage jets



Scan this QR code for more information on our Spa Baths

AVAILABLE SIZES

Roxanne	1500L x 1500W x 590H
Cindy	1400L x 1400W x 580H
Alisha	1300L x 1300W x 620H
Jacqueline	1700L x 800W x 600H
Jacinda	1700L x 850W x 580H

Roxanne



Jacqueline



Alisha



Jacinda



shower tray specifications

900 x 760mm

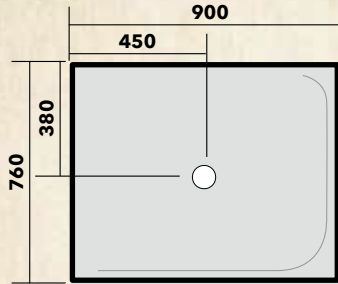

STF49076
Centre Waste - 4 Lip tray
Suit either 3 Sided Alcove or 2 Sided Corner

1200 x 750mm

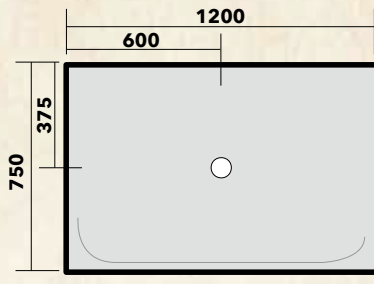

STF41275
Centre Waste. 4 lip tray - suit either
3 Sided Alcove or 2 Sided Corner

1200 x 900mm

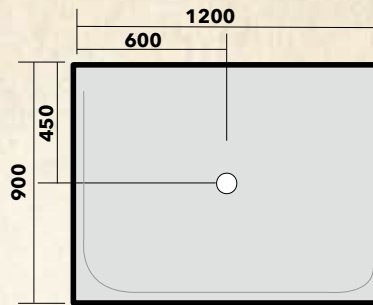

ST41290
Centre Waste - 4 Lip Tray
Suit either 3 Sided Alcove or 2 Sided Corner

Collesium Curved

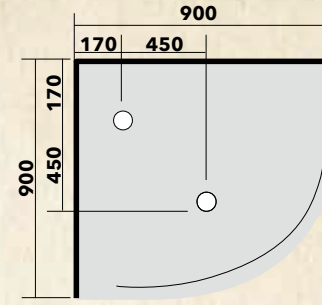

STRR9090 - Rear Corner Waste
STRC9090 - Centre Waste

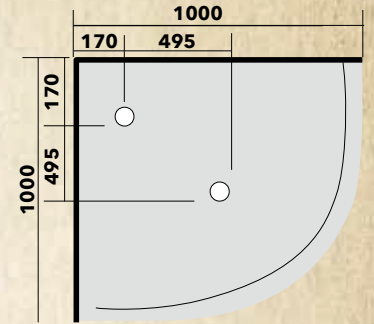

STRR1010 - Rear Corner Waste
STRC1010 - Centre Waste

900 x 900mm

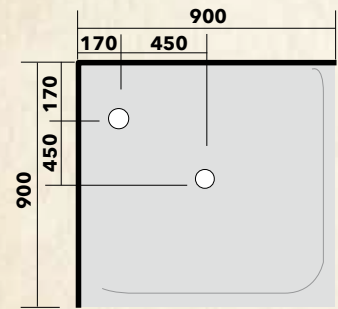

ST29090 - 2 Sided Centre Waste
STF29090 - 2 Sided Freeflow Corner
Waste

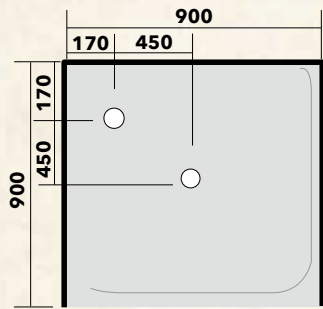

ST39090 - 3 Sided Centre Waste
STF39090 - 3 Sided Freeflow
Corner Waste - **Left rear only**

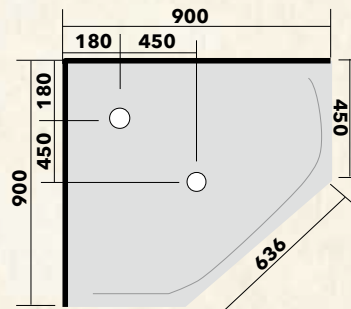

STPC9090 - Centre Waste
STPF9090 - Corner Waste

Dreamline Cube Shower Trays - 2 sided

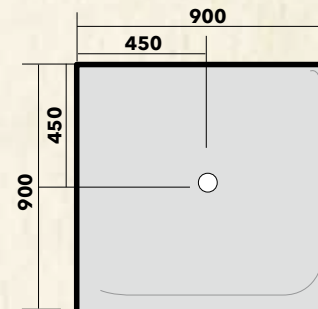

STDL29090 - 2 Sided Centre Waste

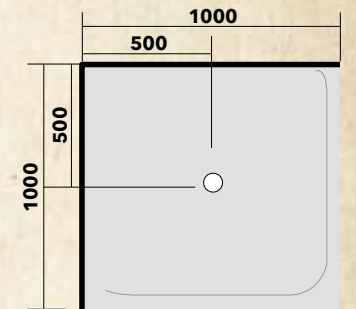

STDL21010 - 2 Sided Centre Waste

1000 x 1000mm

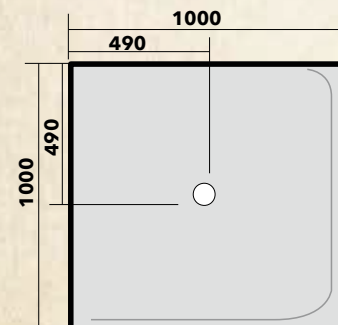

ST21010
2 Sided Centre Waste

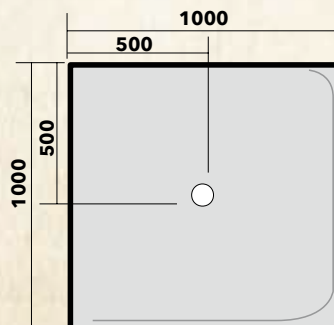

ST31010
3 Sided Alcove Centre Waste

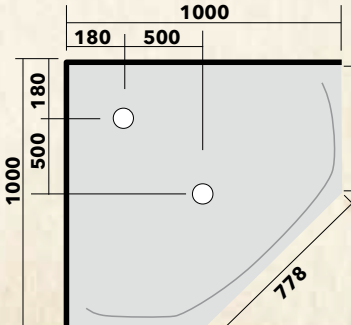

STPC1010 - Centre Waste
STPF1010 - Corner Waste

Visit www.henrybrooks.co.nz
for full tray specifications

shower tray specifications

Dreamline Urban Shower Trays - 2 Sided

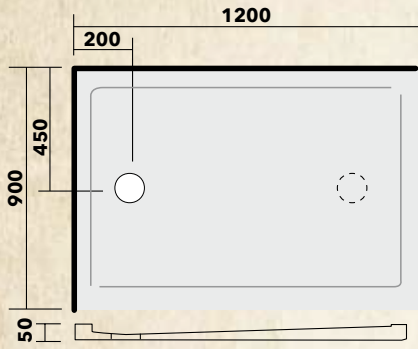

ST1290
2 Sided Left Hand/Right Hand Centre Waste

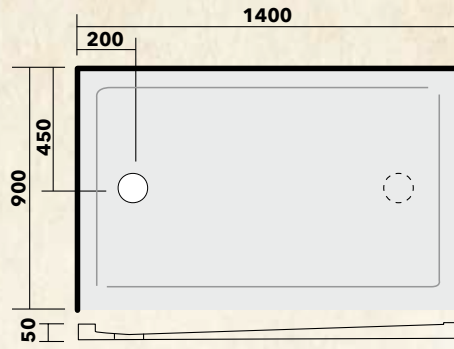

ST1490
2 Sided Left Hand/Right Hand Centre Waste

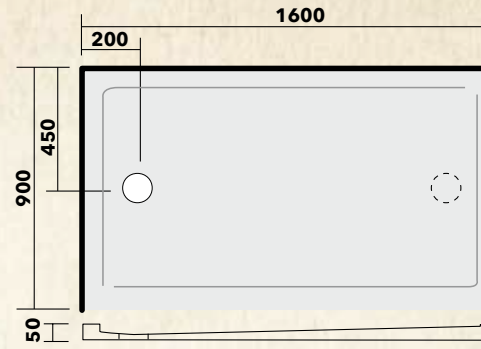

ST1690
2 Sided Left hand/Right hand centre waste

Dreamline Urban Shower Trays - 3 Sided

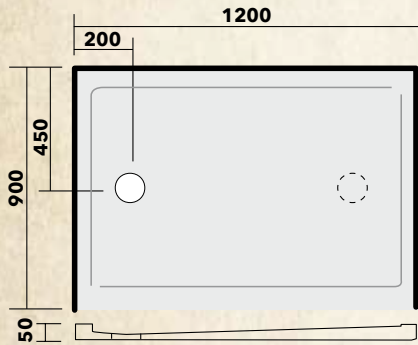

ST1290
3 Sided Left Hand/Right Hand Centre Waste

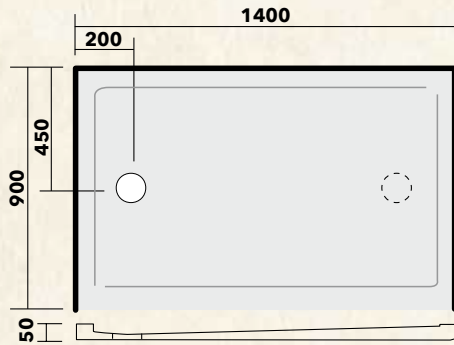

ST1490
3 Sided Left Hand/Right Hand Centre Waste

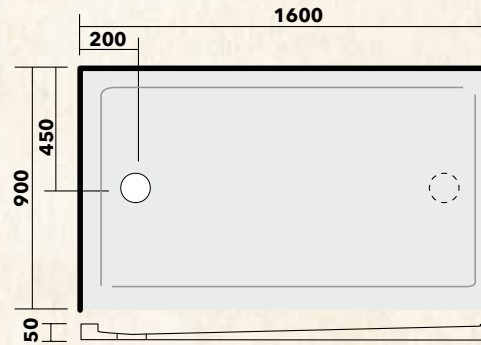

ST1890
3 Sided Left Hand/Right Hand Centre Waste

Dreamline Eclipse Shower Trays - 2 Sided

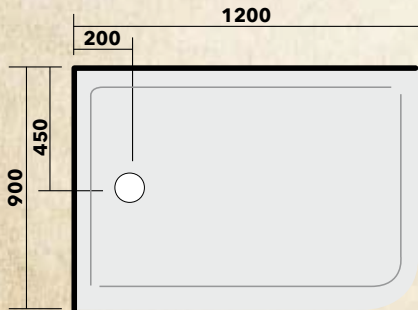

STDLC1290L
2 Sided Left Hand Wall Waste

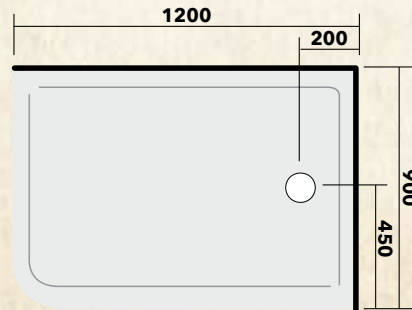

STDLC1290R
2 Sided Right Hand Wall Waste

NOTES

CONTACT DETAILS

Henry Brooks Co.
Head Office: 5 Smales Road, East Tamaki, Auckland
Phone: 09 913 3110 Fax: 09 913 3113
Email: sales@henrybrooks.co.nz
Web: www.henrybrooks.co.nz

V0714